

US

up+tec®

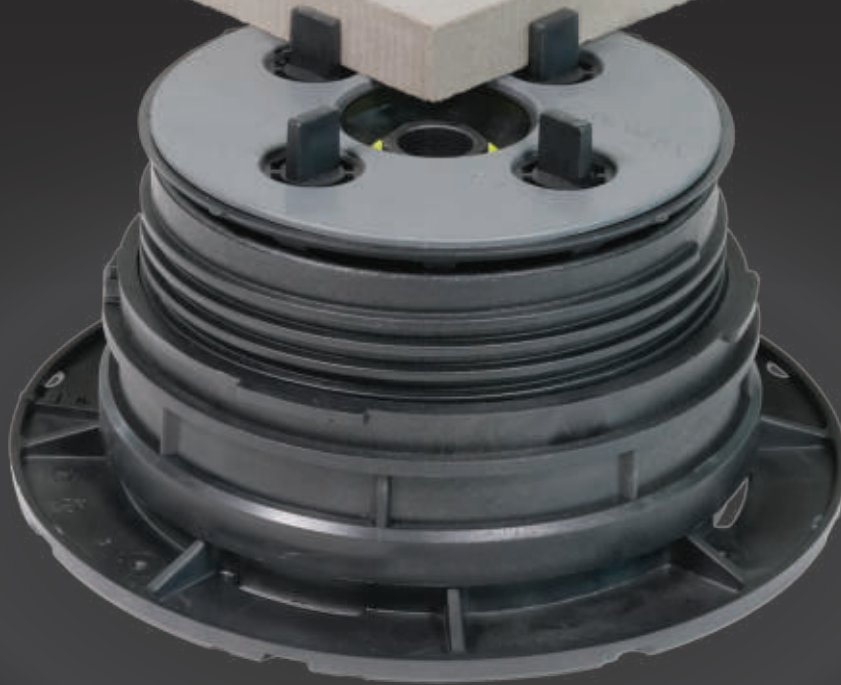

Pedestal system
for raised floors

 profilit+ec
positive profile



up+tec®

Pedestals for raised floors with integrated system that allows the transition from self-levelling to fixed head positioning.

 Patented system

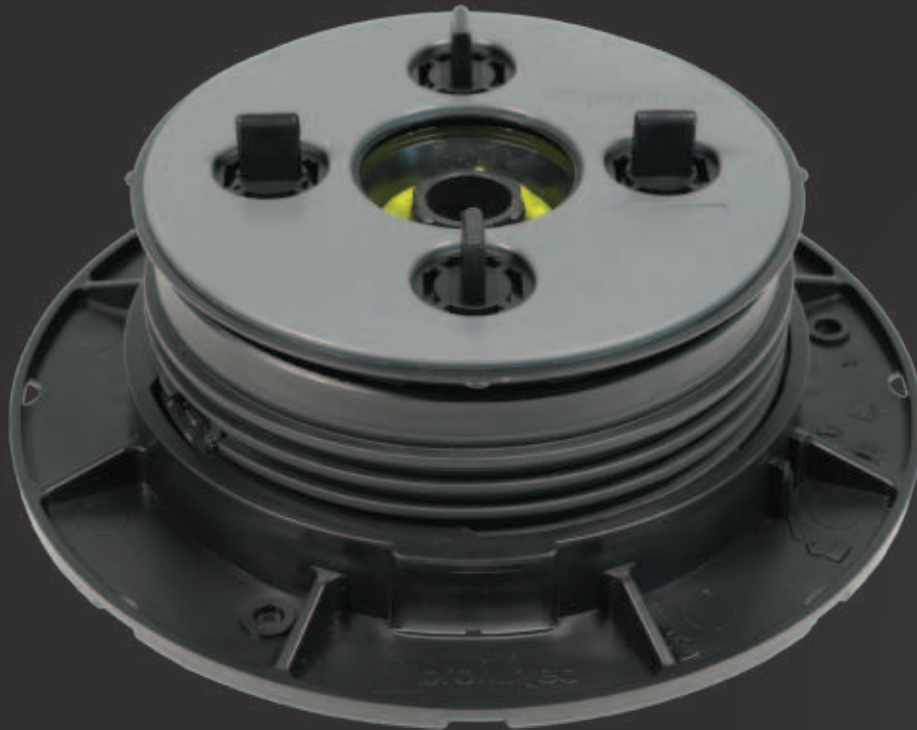

RAISED FLOORS

The installation of raised floors offers benefits that go beyond simple aesthetics. Piping, wiring and drains are located below the finished floor where all water management and other mechanical functions occur which allows for a uniform floor. Further, tile can be easily removed to allow access to these elements while providing high load capabilities. Profilitec's uptec system is the best solution for outdoor raised floors such as terraces, gardens, pool sides, verandas and public places.

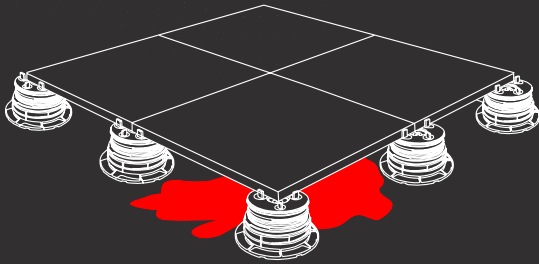

Efficient water management

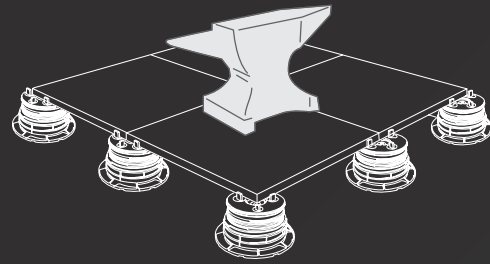

High load resistance

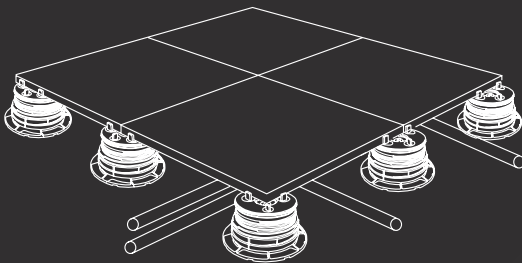

All mechanical elements hidden

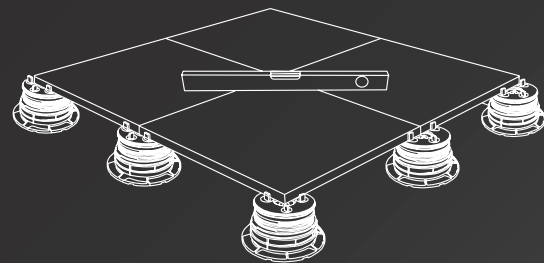

Completely level floor



Applications

Terraces
Poolsides
Roof decks
Walkways

Gazebo
Hot tubs
Gardens
Bars and restaurants



SELF-LEVELLING AND FIXED HEAD PEDESTALS

uptec

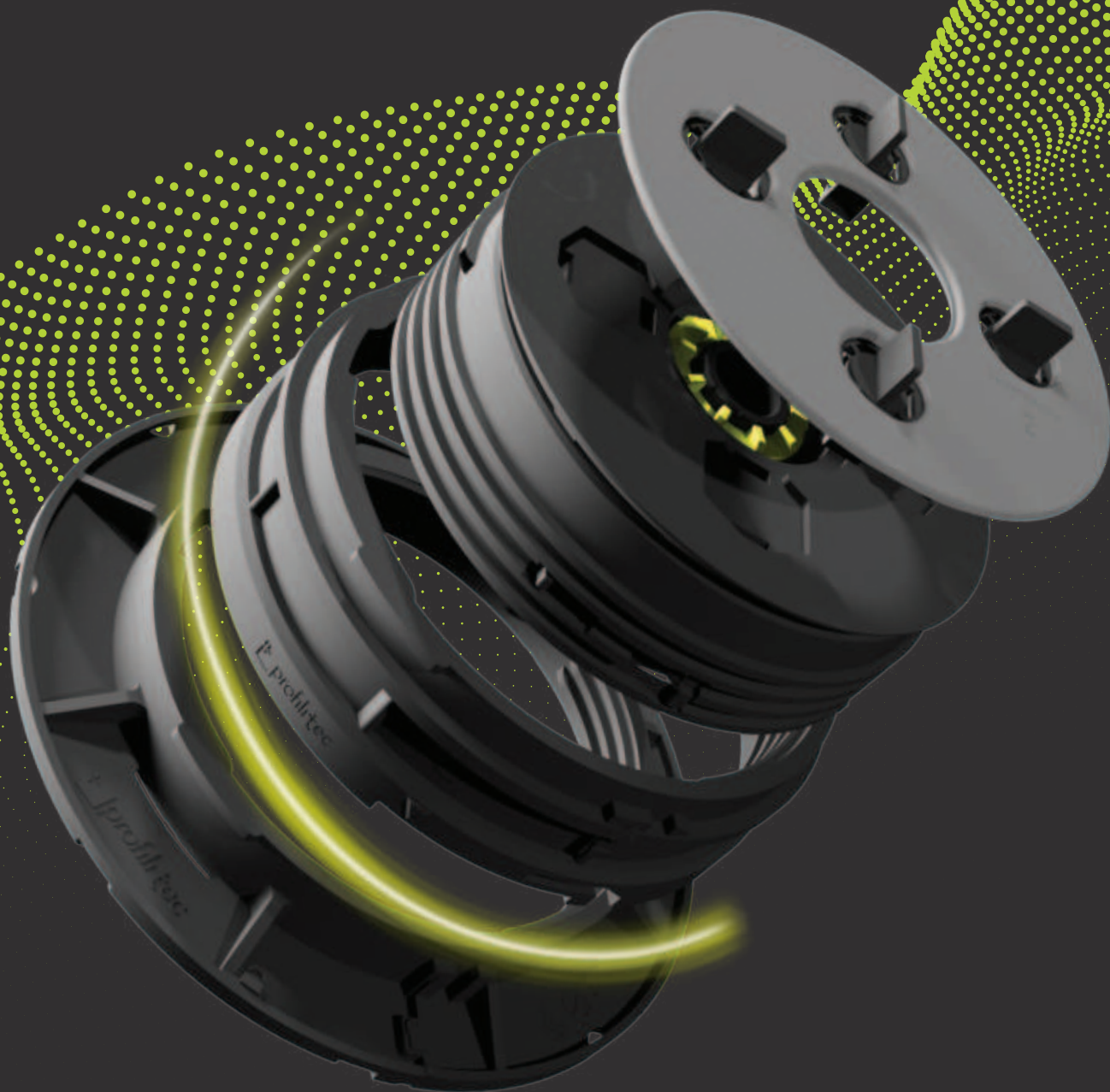



uptec[®] 

Uptec pedestals consist of self-leveling and fixed head supports that are adjustable in height. Based on the **3-in-1** concept, uptec includes 3 base items that minimize inventory levels. The uptec system can be assembled to any height and compensate for up to 5% slope of a structure's surface.

uptec[®]

uptec



SUPAL

Low pedestal



SUPAS

Standard pedestal



SUPAR

Modular ring

combinable with

SUPA2



Head with 3/32"
(2 mm) tabs

SUPA4



Head with 3/16"
(4 mm) tabs

SUPAW

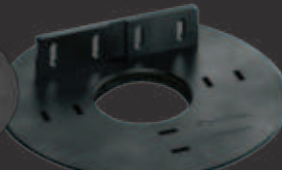

Head to be fixed on
wooden joists

COMPOSITION

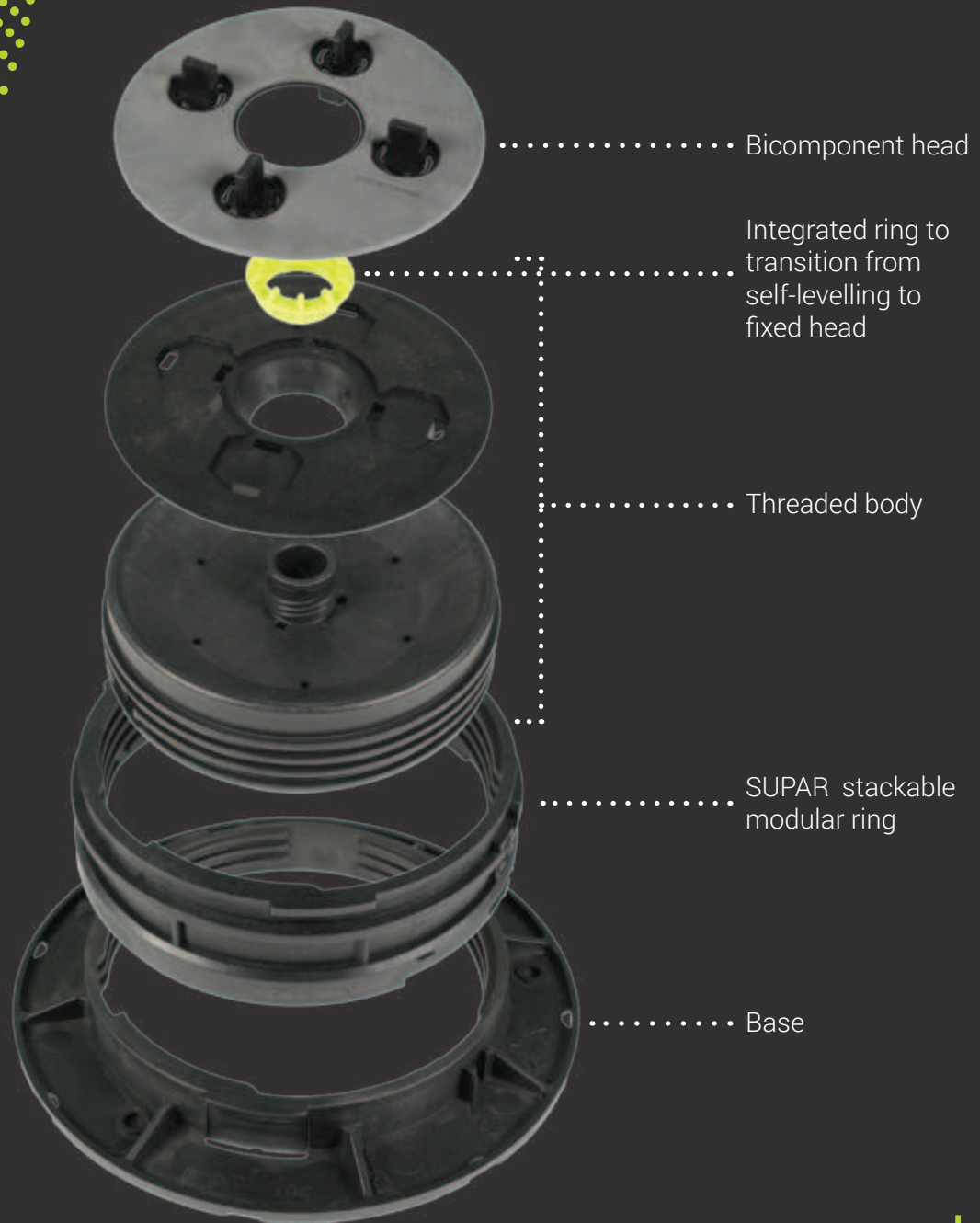

HEIGHT PROGRESSION

The combination of the three base elements along with the special self-levelling or fixed head, enables uptec to reach any height regardless of the sloped surface (5%), providing exceptional versatility.

uptec



Stackable modular rings designed to meet **any installation height** (from 2 1/4" - 58 mm).



uptec

1 SUPAR
+ 1 3/16"
(+ 30 mm)

uptec®

SELF-LEVELLING AND FIXED HEAD

The uptec system incorporates an innovative solution that allows a quick and accurate transition from a self-levelling to a fixed head position with a simple turn of the integrated center ring.

uptec

SELF-LEVELLING



5% SLOPE

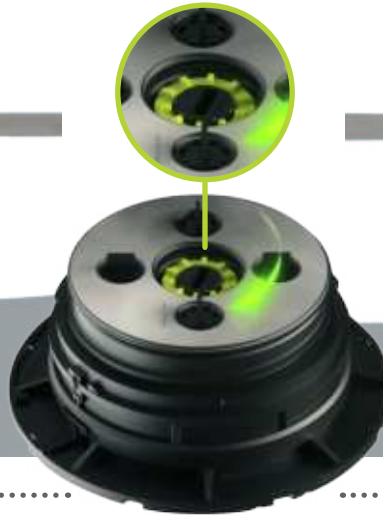

FIXED



0% SLOPE

SUPAK MULTIFUNCTION KEY

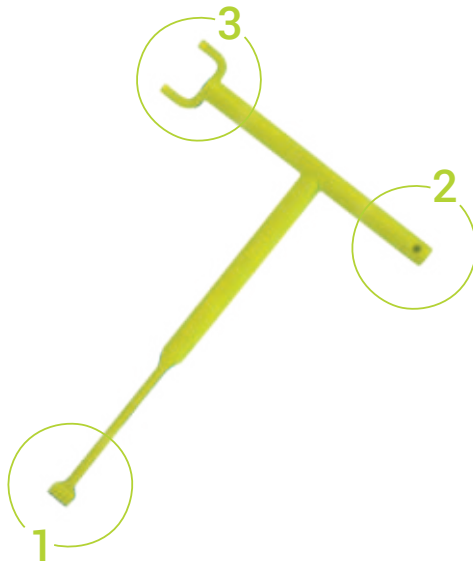

1 Height adjustment

2 Tab removal

3 Self-levelling to fixed head



FEATURES AND FUNCTIONS

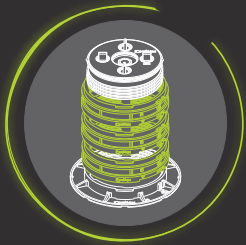

Modularity

Add SUPAR ring to increase the height of the pedestal

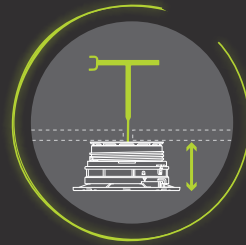

Adjustable height

Height adjustment is achieved on the surface of the pedestal using the SUPAK key even when all tiles are installed



Self-levelling and fixed head

Simple integrated mechanism to transition from self-levelling to fixed head

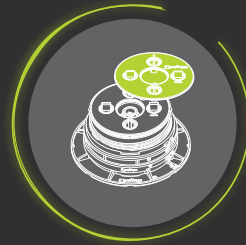

Interchangeable heads

Interchangeable heads for standard, wood or aluminum joist installations



Anti-slip and anti-noise

Heads are equipped with anti-slip and anti-noise rubber to reduce impact sound

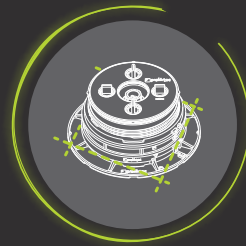

Pre-cut base

Markings on the base allow corner and perimeter placement



Low environmental impact

Made completely from recycled and recyclable material



Load resistance

Resistance to loads up to 3086 lb (1400 kg)



Uptec ground is a support system allowing the installation of raised floors that have minimal height for outdoor use. Two adjustable supports ranging in height from 3/8" (10 mm) to 9/16" (15 mm), SUPT (3/32" - 2 mm joint) or SUPT4 (3/16" - 4 mm joint). Height can be increased by 3/16" (5 mm) using the SUPB stackable accessory (up to a maximum of 3 units).

The system is manually adjustable and does not require the use of an adjustment key.

uptec ground

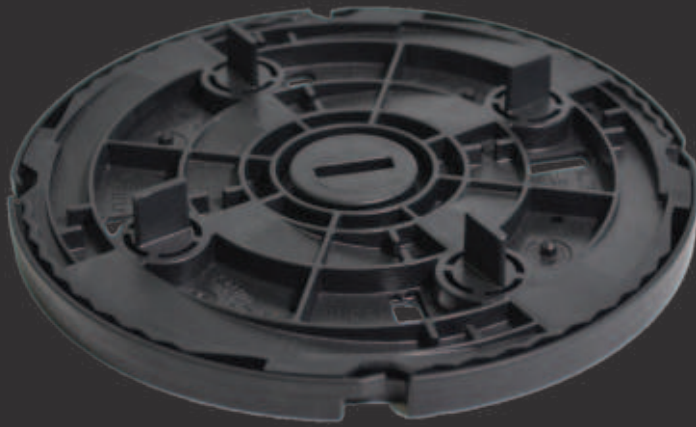

SUPT/ SUPT4

Adjustable pedestal
from 3/8" to 9/16"
(from 10 mm to 15 mm)



SUPB

Extension + 3/16" (+5 mm)

HEIGHT PROGRESSION

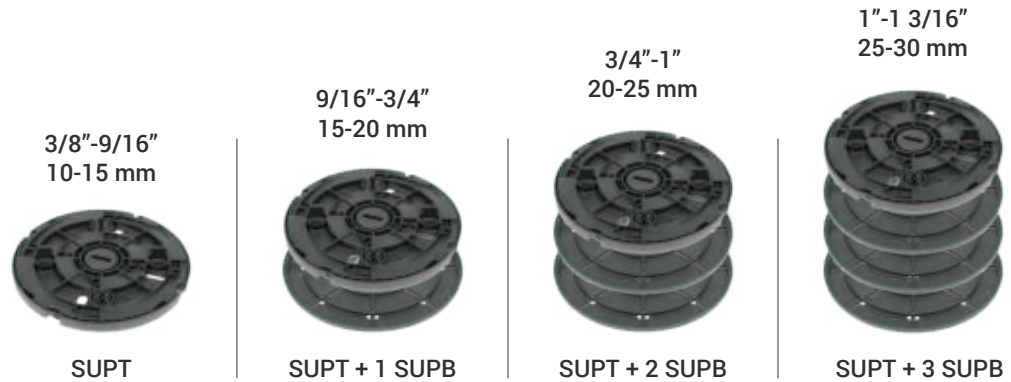

FEATURES AND FUNCTIONS



Height can be adjusted by 1/32" (0.5 mm) increments



Desired height is clearly visible in inches and mm



Made completely from recycled and recyclable material

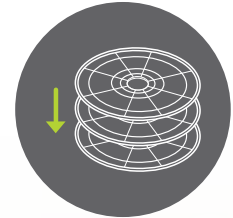

Stackable height extensions

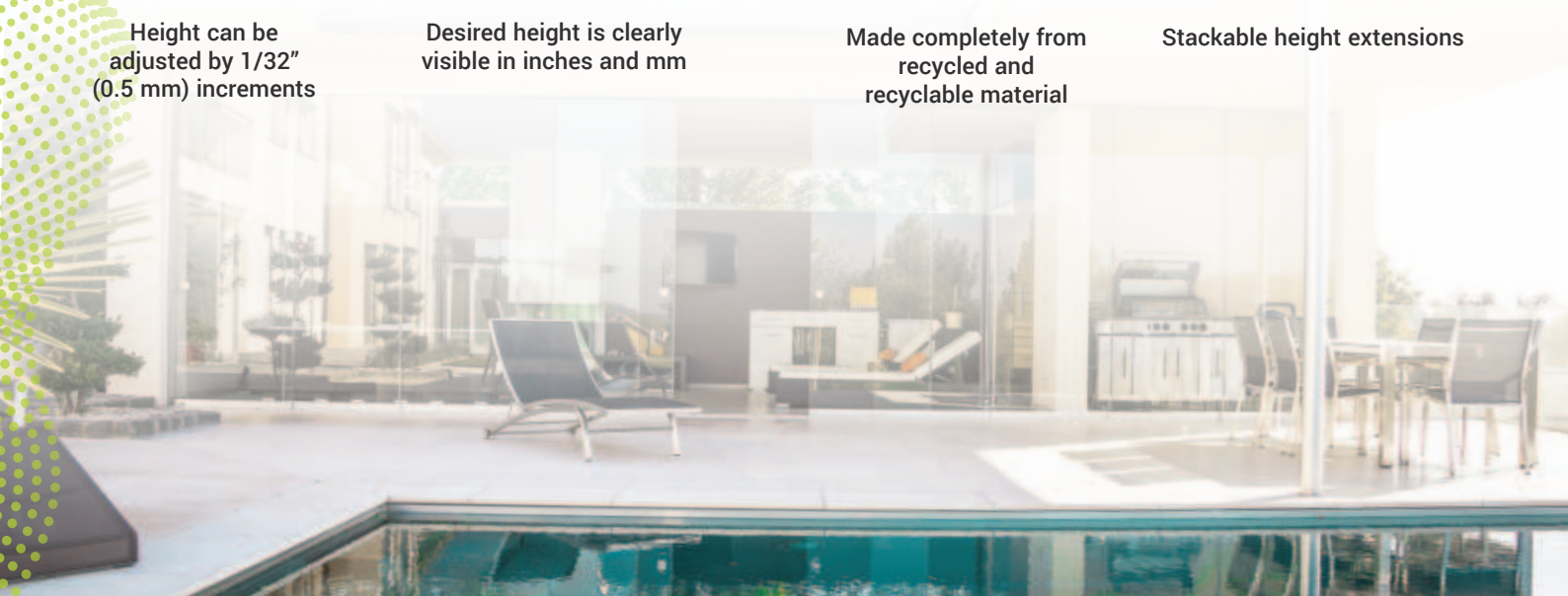

THE MODULARITY OF UPTEC

ADVANTAGES AT THE CONSTRUCTION SITE



Minimized returns

Any leftover items are easily used in future installations.

Installation delays reduced

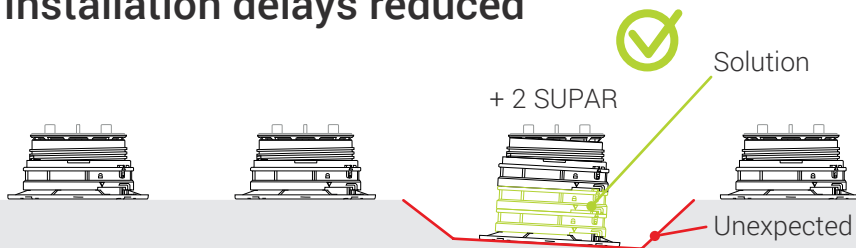

Challenges due to unexpected ground configurations can be quickly resolved eliminating lost time and productivity. Back-and-forth between construction site and warehouse are avoided in case of unexpected complications.



ADVANTAGES IN THE WAREHOUSE



Optimized stock management

Minimal number of SKUs:

- Extremely simplified management of the entire supply chain.
- Minimized returns from the construction site.

Profilitec



Other solutions



Minimum inventory volume and value



Profilitec



Other solutions

PRODUCT ENGINEERING

Profilltec applies state of the art engineering calculation methods to ensure the highest quality and performance standards.

FEM (Finite Element Method) is a numerical technique that is used in load bearing analysis to evaluate the behavior of a product or structure under stress.

Applying the expected loads, the FEM calculates the stresses, deformations, and structural reaction. The results obtained provide an assessment of the stability and thus the safety of the structure, enabling optimization of the design and prevention of possible failure or collapse.

Load distribution



FEM calculation which simulate applied loads to the uptec head reveals that load stress on the threaded body develops vertically throughout the support. This **stress** is **concentrated within the circumference of the threaded body** and is not distributed to the base, which means that because of the larger diameter, uptec has ideal load distribution assuring **high weight resistance**.

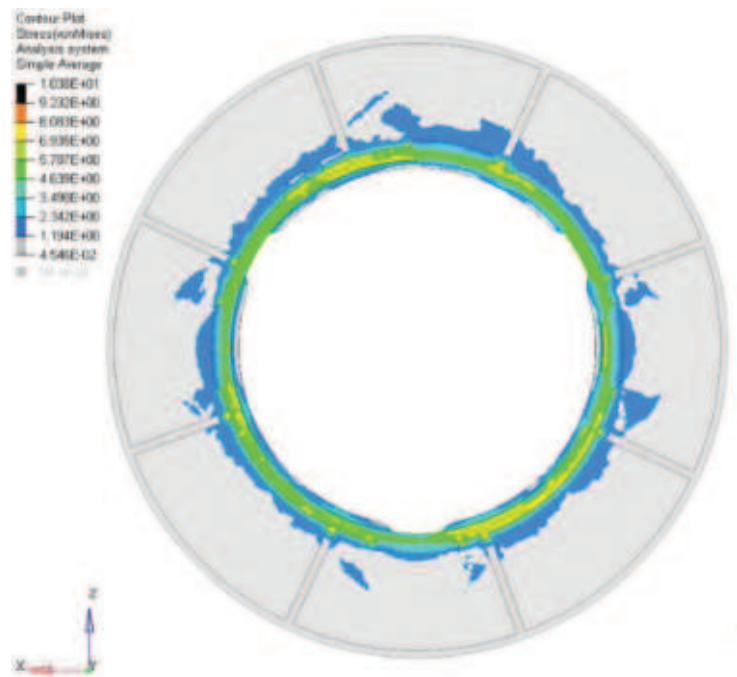
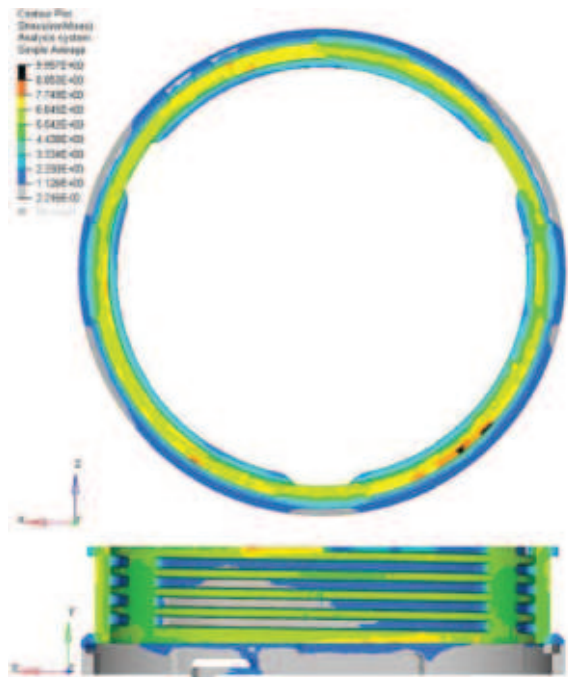

RECORD-BREAKING STRENGTH, STABILITY AND SAFETY

Uptec has exceptional load resistance of 3086 lb - 1400 kg, moreover the large surface head and the diameter of the threaded body offers greater stability to the tile when placed and a perfect load distribution. These features guarantee outstanding safety and stability performance.

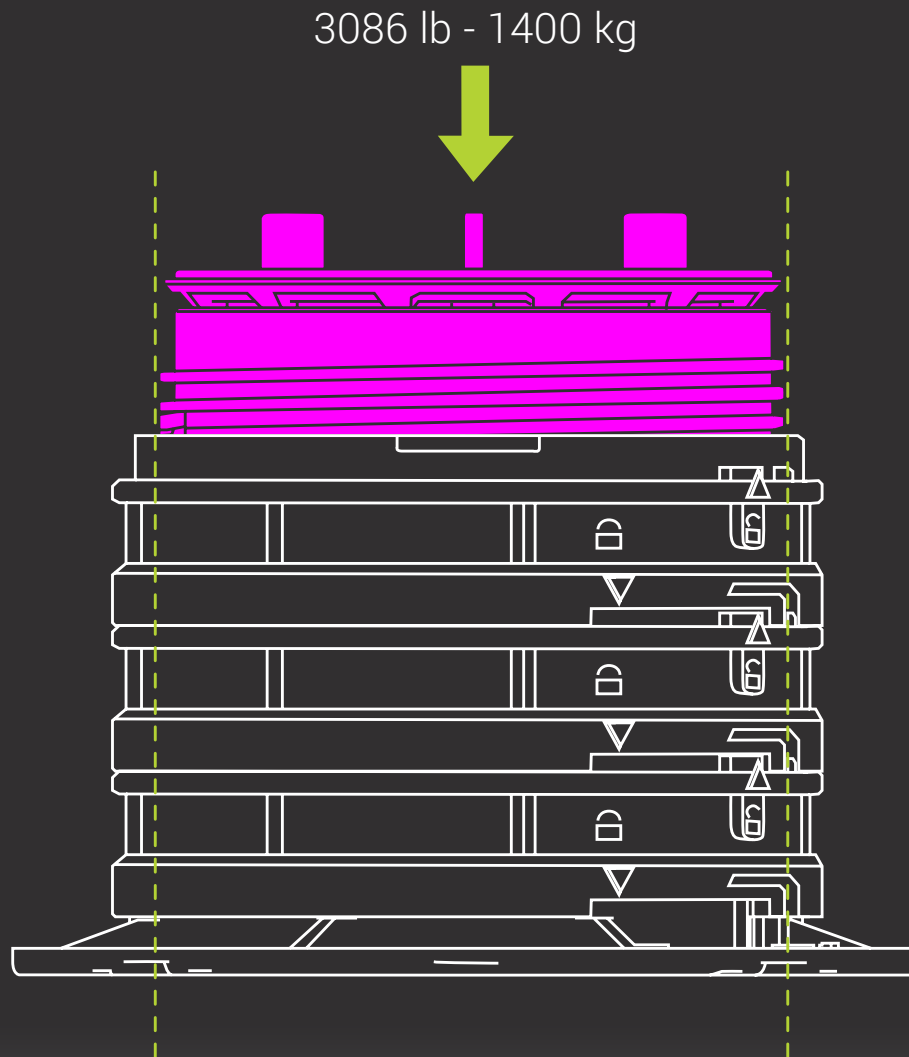

ACCESSORIES

SUPACLPB

Clip for perimeter - Base
to hold 3/4" (2 cm) tiles



SUPACLPT

Clip for perimeter - Head
to hold 3/4" (2 cm) tiles



SUPACLPP

Perimeter tile spacer
to hold tiles

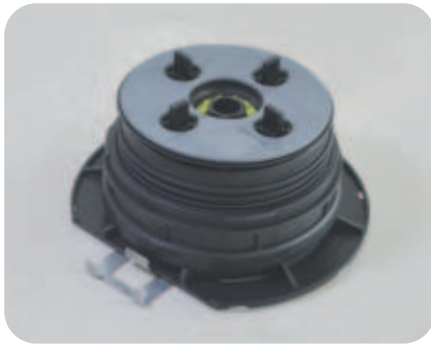

SUPL2 - SUPL3

Leveling disk
3/32" (2 mm) and 1/8" (3 mm) and
slope compensation

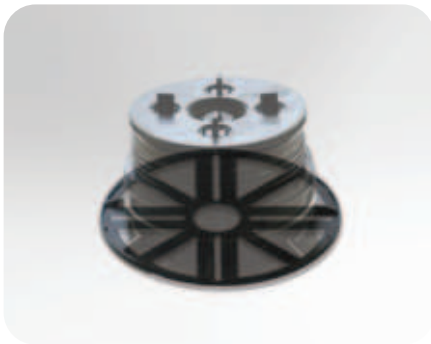

SUPAR120

Modular ring
of 4-3/4" (120 mm)
height



SUPATG

Mat for substrate
protection



PERIMETER BORDERS

Profilitec offers a wide range of high-quality border profiles. Raised floors with the uptec system can be vertically finished with a choice of 3 perimeter profiles that fully meet architectural requirements of installation heights, configurations and colors.

BSJ

Profile with decorative visible surface of 3/4" (2 cm)



BSR

Perimeter profile for 3/4" (2 cm) tiles

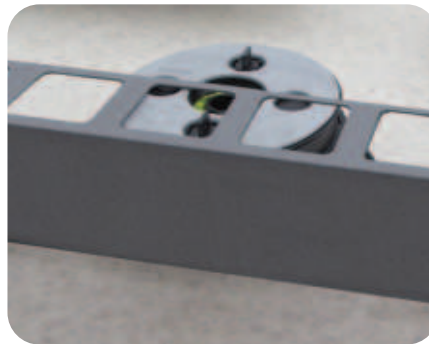

BST

Profile with minimal top-visible edge

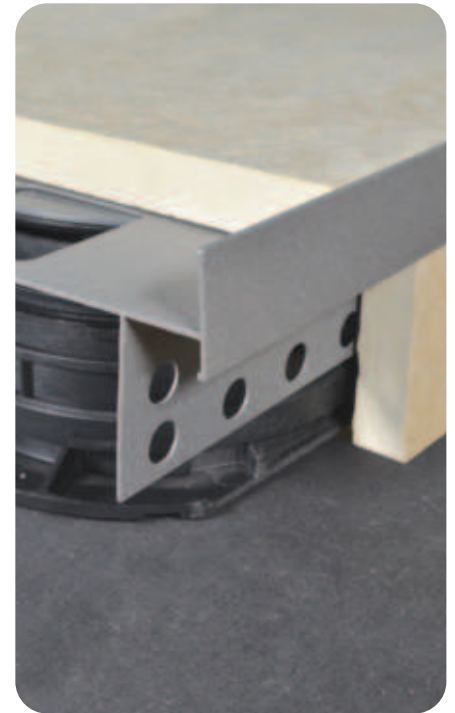

Standard finishes:



Finishes on demand:

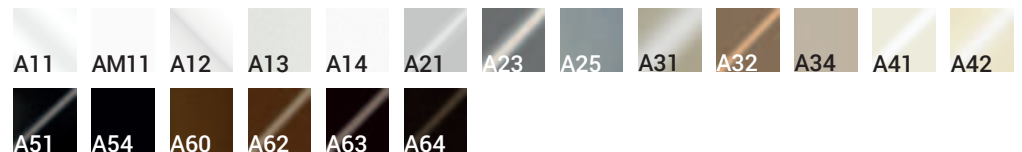

SUPATRAY

The innovative Uptec SUPATRAY is meticulously engineered to provide a versatile and durable raised floor solution to protect against injuries in the event of tile breakage. Featuring a honeycomb structure and dimensions of 23-1/2" x 23-1/2" x 1-1/2" - 598 x 598 x 38 mm, it creates a solid substructure for any raised floor project. Manufactured with recycled ABS plastic material, it is designed to withstand the test of time and the most challenging weather conditions, offering exceptional durability and impressive load-bearing resistance.

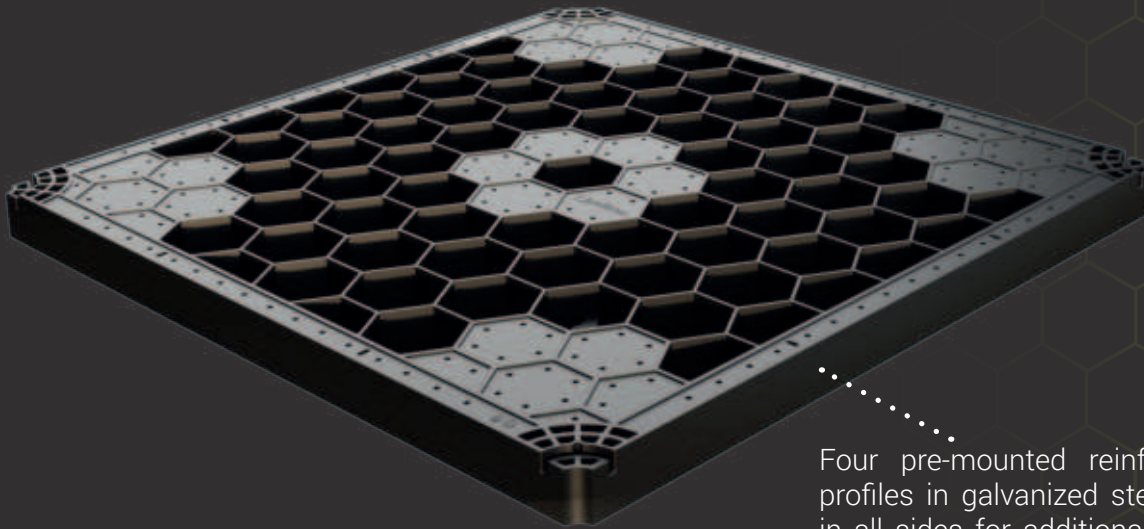

Four pre-mounted reinforcement profiles in galvanized steel placed in all sides for additional strength and stability.



FEATURES AND FUNCTIONS



Ultimate Safety

Unmatched protection against injuries in the event of tile breakage, providing peace of mind.



Effortless Installation

Revolutionizes installation with convenient 23-1/2" x 23-1/2" - 60x60 cm dimensions, drastically reducing time and labor costs.

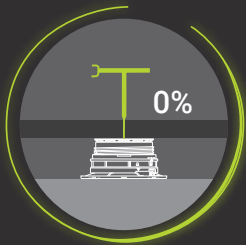

Perfection in Precision

Achieves perfectly level flooring surfaces and offers the possibility for pedestal height adjustment using the SUPAK multifunctional key for absolute precision.

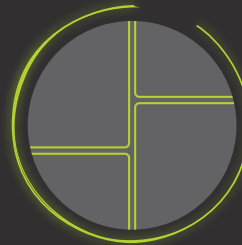

Limitless Creativity

Unleashes boundless creativity, enabling the creation of multiple installation patterns with various tile sizes.



Tailored Adaptability

Can be easily cut to offer individual customization options for curves, recesses, and small edge sections.

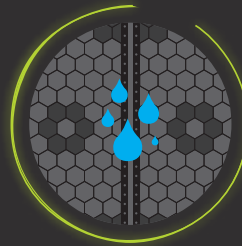

Efficient Drainage

Guarantees drainage efficiency, ensuring rapid water dispersal through joints and its cavities.

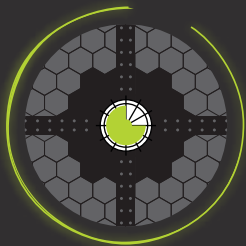

Stability Standard

SUPATRAY is securely connected together by the SUPATRAYLOCK plastic locking disc, ensuring uniformity and maximum stability.



Sustainability

SUPATRAY incorporates recycled content and embraces full recyclability, leading the charge towards a greener future.

SUPATRAY ACCESSORIES

Two helpful accessories are available for state-of-the-art installation. SUPATRAYTAB, rubber disc for anti slip and anti noise performance comes in two different tab sizes (joints of $3/32''$ - 2 mm and $3/16''$ - 4 mm). SUPATRAYLOCK connects four trays for a major stability during installation.

SUPATRAYTAB
for $3/32''$ - 2 mm and
 $3/16''$ - 4 mm joints



SUPATRAYLOCK
Locking Disc
(optional)

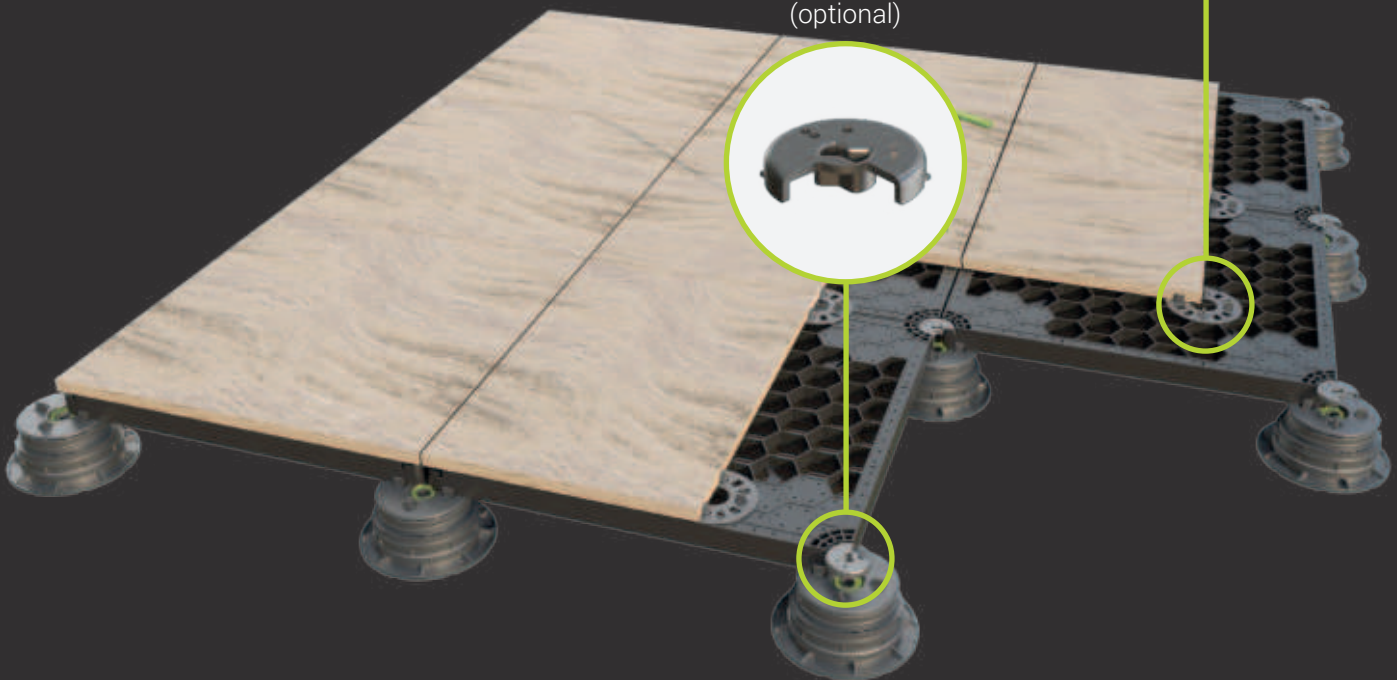

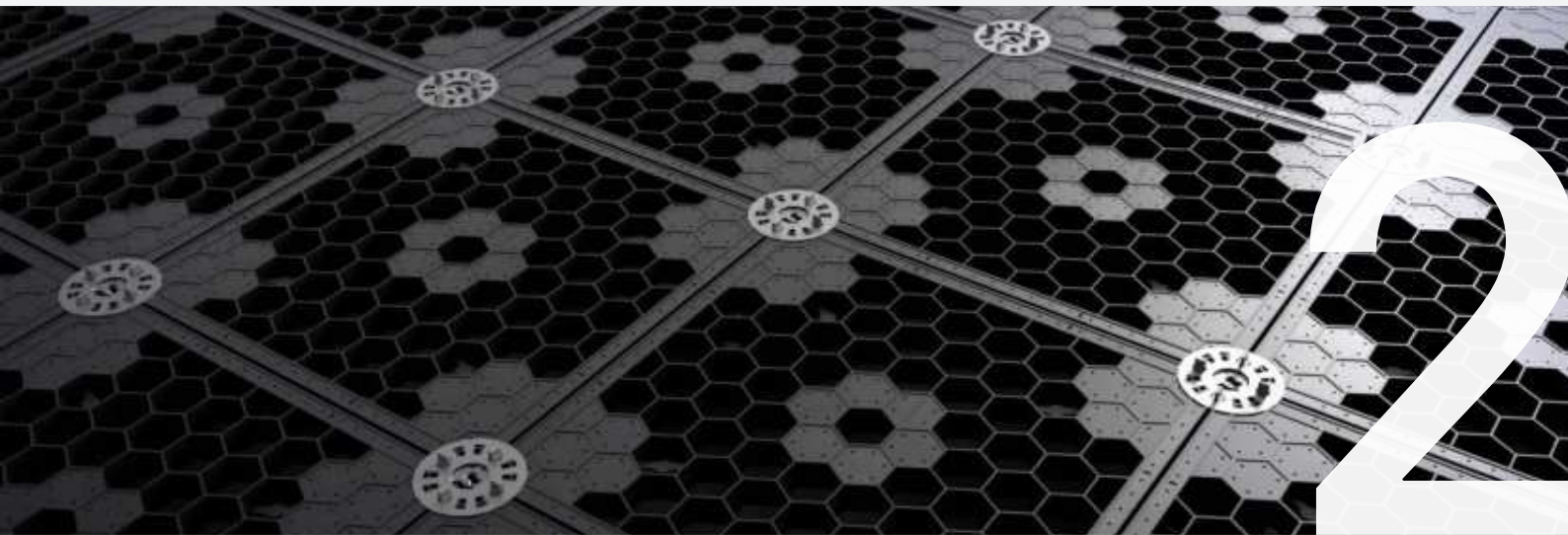

ANTI WIND UPLIFT SYSTEM

The SUPATRAY anti wind uplift system includes a plastic tray featuring three adhesive tracks (perimeter, center, and auxiliary sections), Profilitec adhesive FIXXTEC and the locking disc SUPALOCK.

The assembly process is straightforward. Starting with bonding the porcelain pavers onto the SUPATRAY using FIXXTEC adhesive applied to the tracks. Next, the pedestals are positioned and leveled prior to placing the assembled SUPATRAY atop them. To ensure a level and secure surface, all four corners of the trays are firmly connected using the SUPALOCK disc, subsequently locked-in by using the SUPAK key.

FEATURES AND FUNCTIONS



Invisible

Featuring a hidden lock down system which allows the surface to maintain its original flush aesthetic.



Removable

The system allows for easy inspection of the underlying surface, facilitating maintenance and replacement of tiles if needed.



Fast and safe

Assembly is a straightforward process, eliminating the need to kerf the pavers' sides, preserving their integrity and saving precious time during installation.



Dual function

SUPATRAY acts as wind uplift system and guarantees an anti-fragmentation hazard in case of tile breakage.

COMPOSITION

LOCKING DISC



..... TILE

ANTI FRAGMENTATION
TRAY

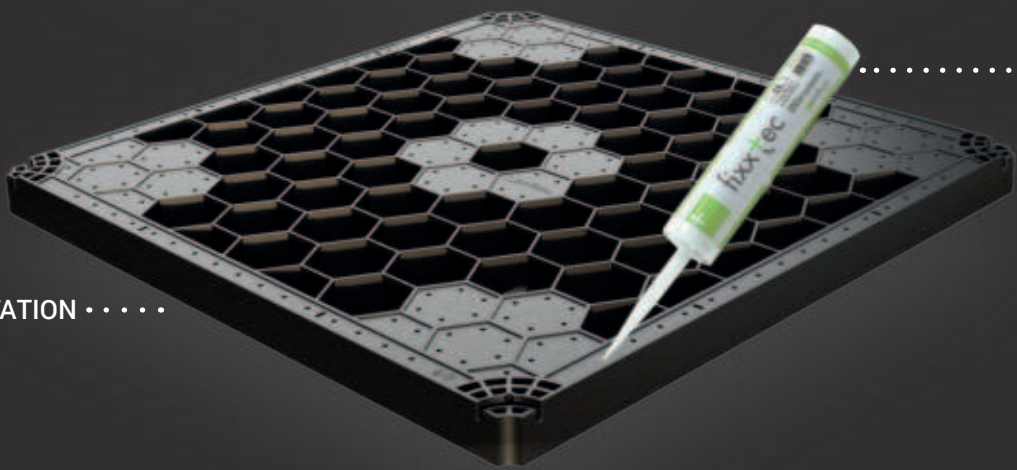

..... ADHESIVE

UPTEC PEDESTAL



PERFORATED JOIST WITH INTEGRATED RUBBER INSERT

SUPAANG240 is a patented aluminum joist for raised floors that offers freedom and flexibility in the choice of materials, size, and flooring installation pattern.

Anti-slip and anti-noise rubber

The top portion has two special rails where anti-slip and anti-noise rubber gaskets are inserted. The joist incorporates pre-applied rubber saving installers valuable time and ensuring a quick and easy installation.

Punched openings

The lower part includes openings that ensure perfect water outflow and allow for height adjustment during and after installation. Additionally, the dented geometry of the openings enables a secure and stable attachment to the head of the pedestal.



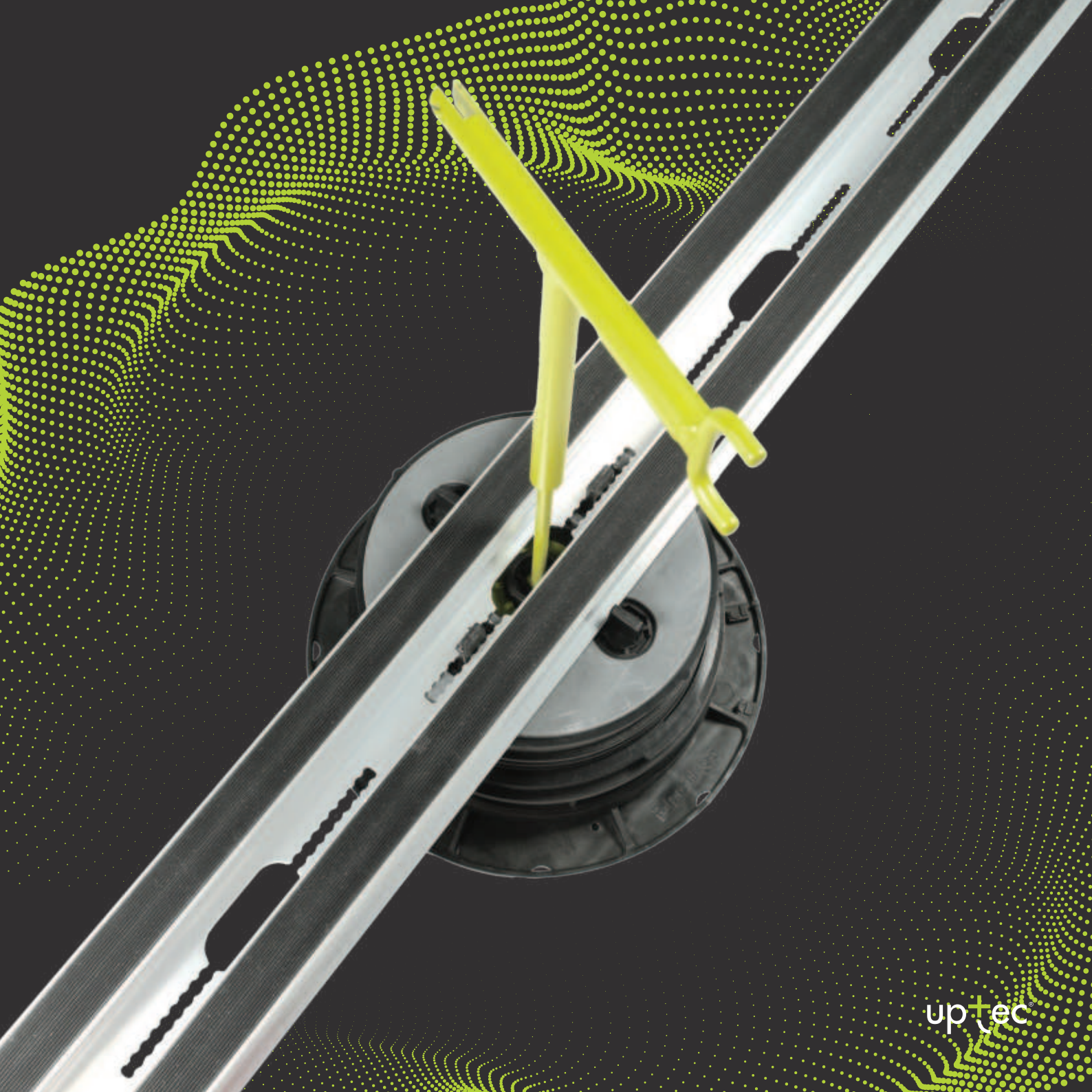

up+ec

FEATURES AND FUNCTIONS



SUPAANG240 provides maximum freedom and flexibility of tile sizes that can be installed, permits a variety of layout options and various covering materials



SUPAANG240 ensures maximum performance for a structurally stable, safe and quick installation

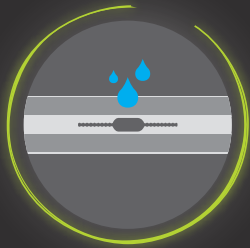

Openings on the base ensure proper water outflow

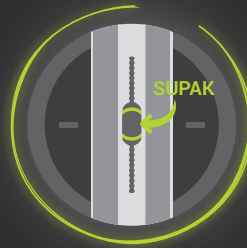

Openings on the base allow height adjustment with the SUPAK key during and after installation



SUPAANG240 comes with the anti-noise integrated rubber inserts

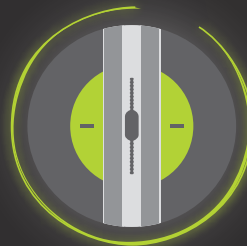

Openings on the base ensure safe and stable attachment to the pedestal head

JOIST SYSTEM ACCESSORIES

SUPDG

Tile spacer
to be used with SUPAANG240



SUPCLIPG

Perimeter and central clips
to be used with decking and in
combination with SUPAANG240



SUPAJG

Joist junction



SUPACLPPT

Perimeter tile spacer
to hold tiles



up+tec[®]

CALCULATOR

www.profilitec.com/uptec-configurator

Uptec pedestal calculator is an online program to create your own raised floor and calculate the number of supports required for your project.

Design your surface area or upload an architectural drawing, choose from an extensive list of tile sizes, select the joint width, and set the desired overall height of the assembly. The Uptec pedestal calculator automatically determines which and how many supports and accessories are required for the project.

It is an easy and intuitive tool that offers a wide range of functions to simplify your work. It also provides additional information such as calculation of tiles to be used and lb (kg) of CO₂ saved per ft (m²) of floor area.



EPD Certification

Uptec is EPD certified. In building assessments, building products are evaluated through environmental product declarations (EPDs) conducted in accordance with ISO 14025 and EN 15804:2012+A2:2019.

The analysis evaluates the life cycle of the Uptec system and measures it in terms of carbon footprint with independent third-party verification of the statement and data, according to ISO 14025:2006. A series of case studies have shown that Uptec has an improvement of more than 70 percent in terms of carbon footprint over traditional methods of exterior floor assembly, such as glued tiles on a lightweight screed.



Discover more



EPD

CERTIFICATION

SYSTEM COMPONENTS AND ACCESSORIES

Code	Product description	Pieces for packaging
SUPAL	Low pedestal	24
SUPAS	Standard pedestal	24
SUPAR	Modular ring of 1 3/16" (30 mm)	24
SUPAR120	Modular ring of 4 3/4" (120 mm)	24
SUPT	Reduced height pedestal with 3/32" (2 mm) tabs	50
SUPT4	Reduced height pedestal with 3/16" (4 mm) tabs	50
SUPB	Extension for SUPT/SUPT4 pedestals	50



SUPAL



SUPAS



SUPAR



SUPAR120



SUPT - SUPT4



SUPB

Code	Product description	Pieces for packaging
SUPA2	Head with 3/32" (2 mm) tabs	240
SUPA4	Head with 3/16" (4 mm) tabs	240
SUPAW	Head to be fixed on wooden joists	240



SUPA2



SUPA4



SUPAW

Code	Product description	Pieces for packaging
SUPATRAY	Anti-fragmentation tray	56

Code	Product description	Pieces for packaging
SUPATRAYLOCK	Locking disc for SUPATRAY	240
SUPALOCK	Aluminum locking disc for SUPATRAY	240
SUPATRAYTAB2	Spacer 3/32" - 2 mm for SUPATRAY	240
SUPATRAYTAB4	Spacer 3/16" - 4 mm for SUPATRAY	240

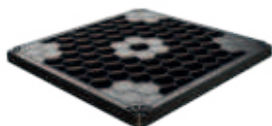

SUPATRAY



SUPATRAYLOCK



SUPATRAYTAB2



SUPATRAYTAB4

Code	Product description	Pieces for packaging
SUPAANG240	Aluminum joist for SUPA4	10
SUPAANGB240	Black aluminum joist for SUPA4	10
SUPDG2	Tile spacer 3/32" - 2 mm	500
SUPDG	Tile spacer 3/16" - 4 mm	500
SUPCLIPG	Perimeter and central clips (Deck)	50
SUPAJGSET20	Joint for joist	20
SUPACLPPT	Perimeter clip to hold tiles	5



SUPAANG240 - SUPAANGB240



SUPDG2 - SUPDG



SUPCLIPG



SUPAJG



SUPACLPPT

Code	Product description	Pieces for packaging
BSJ	Perimeter profile	10
BSR	Perimeter profile	5/10
BST20	Perimeter profile	5
SUPL2	3/32" (2 mm) leveling disk	600
SUPL3	1/8" (3 mm) leveling disk	500
SUPATG	Mat to protect the substrate	24
SUPACLPBSET5	Perimeter clip - Base	5
SUPACLPTSET5	Perimeter clip - Head	5
SUPACLPPSET5	Perimeter clip	5
SUPAK	Multifunction key	1



BSJ



BSR



BST



SUPAK



SUPL2 - SUPL3



SUPATG



SUPACLPB



SUPACLPT



SUPACLPP

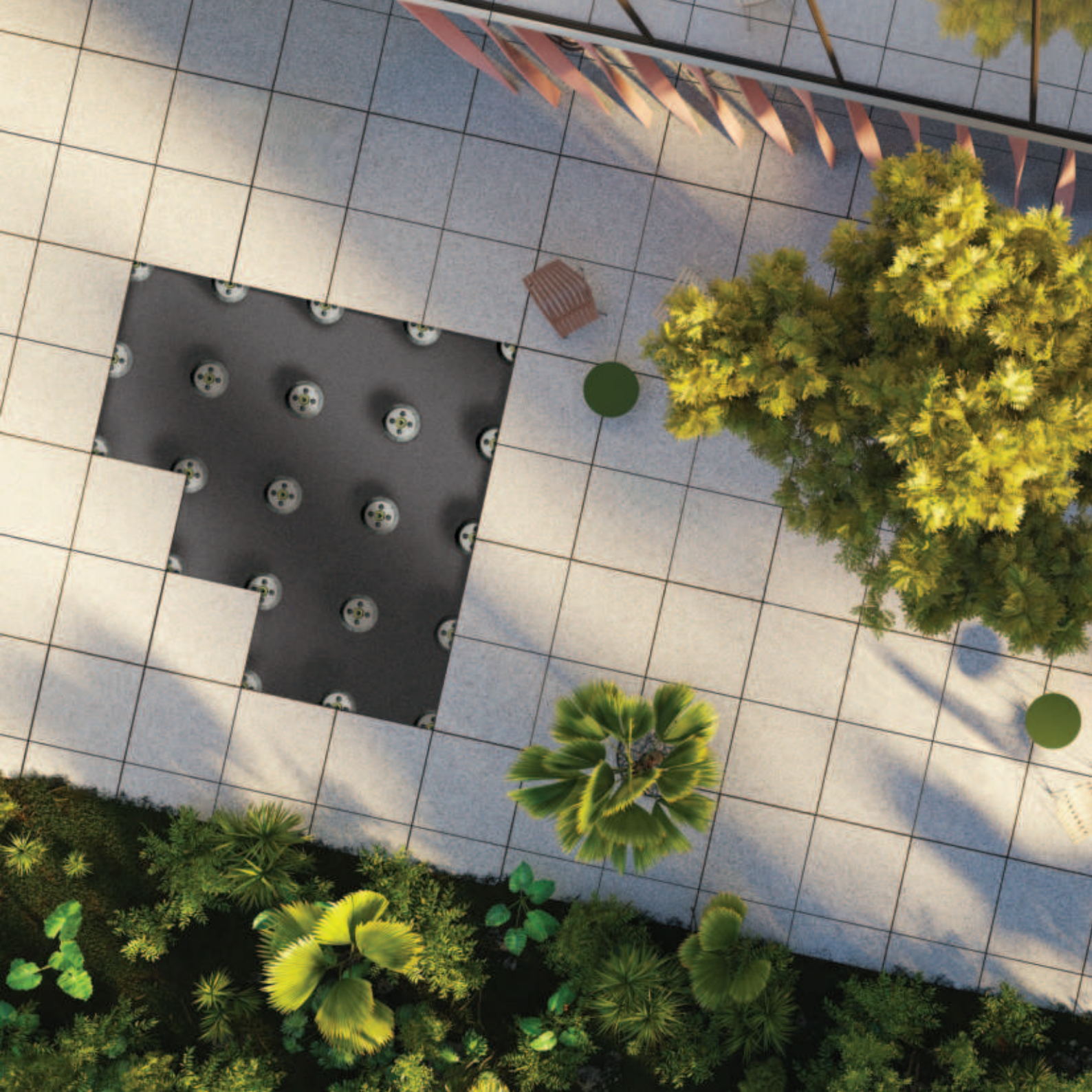

up+tec[®]



www.profilitec.com



Profilitec S.p.A.

Via Scotte, 3
36033 Isola Vicentina
(Vicenza) Italy



profilitec@profilitec.com



+39 0444 268311

Profilitec Corp.

472 Meeting Street
Suite C - #301
Charleston, SC 29403, USA

customerservice@profilitec.com

+1 855 290 9591

Profilitec Ibérica S.L.

Camí de Betxí, 2
12540 Castellón
Vila-Real, España

iberica@profilitec.com

+34 964 18 29 84

BOOKUPT/US



Rev. 06/24